

# QuickShot™

## 3A9301F

EN



### Important Safety Instructions

Read all warnings and instructions in this manual, on the unit, and in the battery and charger manual before using the equipment. Be familiar with the controls and the proper usage of the equipment. Save these instructions.



### Important Medical Information

Read the medical alert card provided with the gun. It contains injection injury treatment information for a doctor. Keep it with you when operating the equipment.

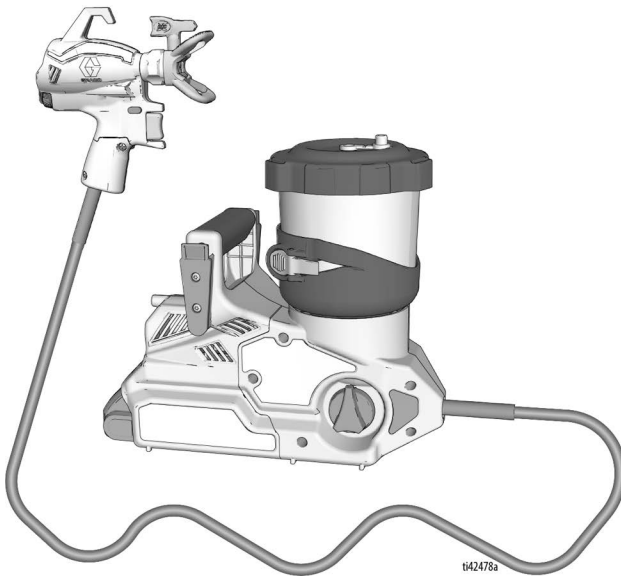

Additional Manual Languages

ti42478a

**POWERED BY**

**DEWALT**





**SERVICE**  
 to every customer, every time

[www.graco.com/techsupport](http://www.graco.com/techsupport)





*For portable spray applications of architectural paints and coatings only.  
Not approved for use in explosive atmospheres or hazardous (classified) locations.  
For professional use only.*

PROVEN QUALITY. LEADING TECHNOLOGY.

## Contents

<b>Models</b> .....	<b>3</b>
Related Manuals .....	3
<b>Important Grounding Information</b> .....	<b>4</b>
<b>Warnings</b> .....	<b>5</b>
<b>Know Your Sprayer</b> .....	<b>8</b>
<b>Know Your Controls</b> .....	<b>9</b>
<b>Grounding Instructions</b> .....	<b>10</b>
(Oil-Based or Flammable Materials) .....	10
Pails .....	10
<b>Setup</b> .....	<b>11</b>
Pressure Relief Procedure .....	11
Sprayer Setup .....	12
Belt Setup .....	13
<b>Startup</b> .....	<b>14</b>
<b>Spraying</b> .....	<b>16</b>
Flow Control .....	16
Tip and Pressure Selection .....	16
Spray Tip Orientation .....	16
Spray Techniques .....	17
Aiming Spray Gun .....	17
Triggering Timing .....	17
Spray Pattern Quality .....	17
Clear Tip Clogs .....	18
Spray Tip Installation .....	19
Cup Refills .....	20
Pause in Spraying .....	21
<b>Cleanup</b> .....	<b>22</b>
Cleaning Sprayer .....	22
<b>Storage</b> .....	<b>25</b>
<b>Reference</b> .....	<b>26</b>
Cleaning Fluid Compatibility .....	26
<b>Recycling and Disposal</b> .....	<b>27</b>
End of Product Life .....	27
<b>Troubleshooting</b> .....	<b>28</b>
<b>Advanced Troubleshooting</b> .....	<b>32</b>
Debris in Pump or Gun .....	32
Assembly Verification .....	35
<b>Replacement Parts</b> .....	<b>36</b>
Parts List .....	37
<b>Replacement Parts</b> .....	<b>39</b>
Extended Repair Parts .....	39
<b>Technical Specifications</b> .....	<b>40</b>
<b>Graco Standard Warranty</b> .....	<b>41</b>

## Models

Approvals	Model	Sprayer Name	Charger Voltage	Tip Family	Tip Size
 110474 Certified to CAN/CSA C22.2 No. 68 Conforms to UL 1450	20B473	Ultra QuickShot NA	120V	FFLPxxx	0.008 – 0.016 in. (0.20 – 0.41 mm)
	826308	Ultimate QuickShot NA	120V		
	20B476	Ultra QuickShot	230V CEE		
	20B477	Ultra QuickShot Japan	100V		
	20B478	Ultra QuickShot Korean	230V		
	20B479	Ultra QuickShot ANZ	230V		
	20B475	Ultra QuickShot UK	230V		

Maximum Working Pressure: 2000 psi (138 bar, 14 MPa)

Compatible with the following DeWALT batteries: DCB183 and DCB203

## Related Manuals

Manual in English	Description
	DeWALT charger manual

## Operational video

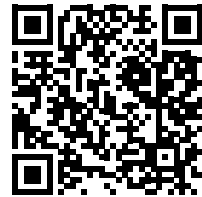

[graco.com/quickshotsupport](http://graco.com/quickshotsupport)



# Important Grounding Information

## Important Grounding Information

The following information is intended to help you understand when to use the grounding wire provided with your sprayer.

Please read the information on the material container label to determine if it is oil-based or flammable. Ask for a Safety Data Sheet (SDS) from your supplier. The container label and SDS will explain the contents of the material and the specific precautions related to it.

Paints, coatings and clean-up materials generally fit into one of the following **3 basic types**:

<b>Grounding Wire and Clamp Required?</b>	<b>Type of Flushing or Cleaning Material</b>
<b>No</b>	<b>WATER-BASED:</b> The container label should indicate that the material can be cleaned up with soap and water.
<b>Yes</b> 	<b>OIL-BASED:</b> The container label should indicate that the material is COMBUSTIBLE and can be cleaned up with mineral spirits or non-flammable paint thinner. Use oil-based material outdoors or in a well-ventilated indoor area with a flow of fresh air. See the safety warnings in this manual. Follow <b>Grounding Instructions</b> , page 10, when using this type of material.
<b>Yes</b> 	<b>FLAMMABLE:</b> This type of material contains flammable solvents such as xylene, toluene, naphtha, MEK, lacquer thinner, acetone, denatured alcohol, and turpentine. The container label should indicate that this material is FLAMMABLE. Use flammable materials outdoors or in a well-ventilated area with a flow of fresh air. Follow <b>Grounding Instructions</b> , page 10, when using this type of material.

# Warnings

The following warnings are for the setup, use, grounding, maintenance, and repair of this equipment. The exclamation point symbol alerts you to a general warning and the hazard symbols refer to procedure-specific risks. When these symbols appear in the body of this manual or on warning labels, refer back to these Warnings. Product-specific hazard symbols and warnings not covered in this section may appear throughout the body of this manual where applicable.

## **WARNING**



### **FIRE AND EXPLOSION HAZARD**

Flammable fumes, such as solvent and paint fumes, in work area can ignite or explode. To help prevent fire and explosion:



- Do not spray flammable or combustible materials near an open flame or sources of ignition such as cigarettes, motors, and electrical equipment.



- Do not use a paint or a solvent containing halogenated hydrocarbons.
- Keep spray area well-ventilated. Keep a good supply of fresh air moving through the area.



- Sprayer generates sparks. Keep pump assembly in a well-ventilated area when spraying, flushing, cleaning, or servicing. Do not spray pump assembly.
- Do not smoke in the spray area or spray where sparks or flame is present.
- Do not operate light switches, engines, or similar spark producing products in the spray area.
- Keep area clean and free of paint or solvent containers, rags, and other flammable materials.
- Know the contents of the paints and solvents being sprayed. Read all Safety Data Sheets (SDSs) and container labels provided with the paints and solvents. Follow the paint and solvent manufacturer's safety instructions.
- Keep a working fire extinguisher in the work area.

### **Oil-based or Flammable Materials**

Paint or solvent flowing through the equipment is able to result in static electricity. Static electricity creates a risk of fire or explosion in the presence of paint or solvent fumes. To help prevent fire and explosion when using oil-based or flammable materials:

- Connect the grounding wire and plug to a true earth ground.
- If there is static sparking or if you feel a static charge, stop operation immediately. Do not use sprayer until you identify and correct the problem.
- All parts of the spray system, including the pump, hose assembly, spray gun, and objects in and around the spray area shall be properly grounded to protect against static discharge and sparks. Use Graco conductive or grounded high-pressure airless paint sprayer hoses. Follow **Grounding Instructions**, page 10.
- Verify that all containers and collection systems are grounded to prevent static discharge. Do not use pail liners unless they are anti-static or conductive.

# Warnings

## **WARNING**



### **SKIN INJECTION HAZARD**

High-pressure spray is able to inject toxins into the body and cause serious injury that can result in amputation. In the event that injection occurs, **get immediate surgical treatment.**



- Do not aim the gun at, or spray any person or animal.
- Keep hands and other body parts away from the discharge. For example, do not try to stop leaks with any part of the body.
- Always use the spray tip guard. Do not spray without spray tip guard in place.
- Use Graco spray tips.
- Use caution when cleaning and changing spray tips. In the case where the spray tip clogs while spraying, follow the **Pressure Relief Procedure** for turning off the unit and relieving the pressure before removing the spray tip to clean.
- Equipment maintains pressure after power is shut off. Do not leave the equipment energized or under pressure while unattended. Follow the **Pressure Relief Procedure** when the equipment is unattended or not in use, and before servicing, cleaning, or removing parts.
- Check hoses and parts for signs of damage. Replace any damaged hoses and parts.
- This system is capable of producing 2000 psi (138 bar, 13.8 MPa). Use Graco parts or accessories that are rated a minimum of 2000 psi (138 bar, 13.8 MPa).
- Always engage the trigger lock when not spraying. Verify the trigger lock is functioning properly.
- Verify that all connections are secure before operating the unit.
- Know how to stop the unit and bleed pressure quickly. Be thoroughly familiar with the controls.



### **EQUIPMENT MISUSE HAZARD**

Misuse can cause death or serious injury.



- Always wear appropriate gloves, eye protection, and a respirator or mask when painting.
- Do not operate or spray near children. Keep children away from equipment at all times.
- Do not overreach or stand on an unstable support. Keep effective footing and balance at all times.
- Stay alert and watch what you are doing.
- Do not operate the unit when fatigued or under the influence of drugs or alcohol.
- Do not kink or over-bend the hose.
- Do not expose the hose to temperatures or to pressures in excess of those specified by Graco.
- Do not use the hose as a strength member to pull or lift the equipment.
- Do not alter or modify equipment. Alterations or modifications may void agency approvals and create safety hazards.
- Make sure all equipment is rated and approved for the environment in which you are using it.

## **WARNING**



### **PRESSURIZED ALUMINUM PARTS HAZARD**

Use of fluids that are incompatible with aluminum in pressurized equipment can cause serious chemical reaction and equipment rupture. Failure to follow this warning can result in death, serious injury, or property damage.

- Do not use 1,1,1-trichloroethane, methylene chloride, other halogenated hydrocarbon solvents or fluids containing such solvents.
- Do not use chlorine bleach.
- Many other fluids may contain chemicals that can react with aluminum. Contact your material supplier for compatibility.



### **BATTERY AND CHARGER COMPATIBILITY HAZARD**



- Only use DEWALT brand 18V Max or 20V Max batteries and battery chargers with this tool.
- READ ALL INSTRUCTIONS included with this tool regarding the safety and usage of DEWALT batteries and battery chargers.
- Do not wash or spray down battery.
- Do not clean the battery with anything other than a cloth moistened with water.



### **TOXIC FLUID OR FUMES HAZARD**

Toxic fluids or fumes can cause serious injury or death if splashed in the eyes or on skin, inhaled, or swallowed.

- Read Safety Data Sheets (SDSs) to know the specific hazards of the fluids you are using.
- Store hazardous fluid in approved containers, and dispose of it according to applicable guidelines.



### **PERSONAL PROTECTIVE EQUIPMENT**

Wear appropriate protective equipment when in the work area to help prevent serious injury, including eye injury, hearing loss, inhalation of toxic fumes, and burns. Protective equipment includes but is not limited to:

- Protective eyewear, and hearing protection.
- Respirators, protective clothing, and gloves as recommended by the fluid and solvent manufacturer.

# Know Your Sprayer

## Know Your Sprayer

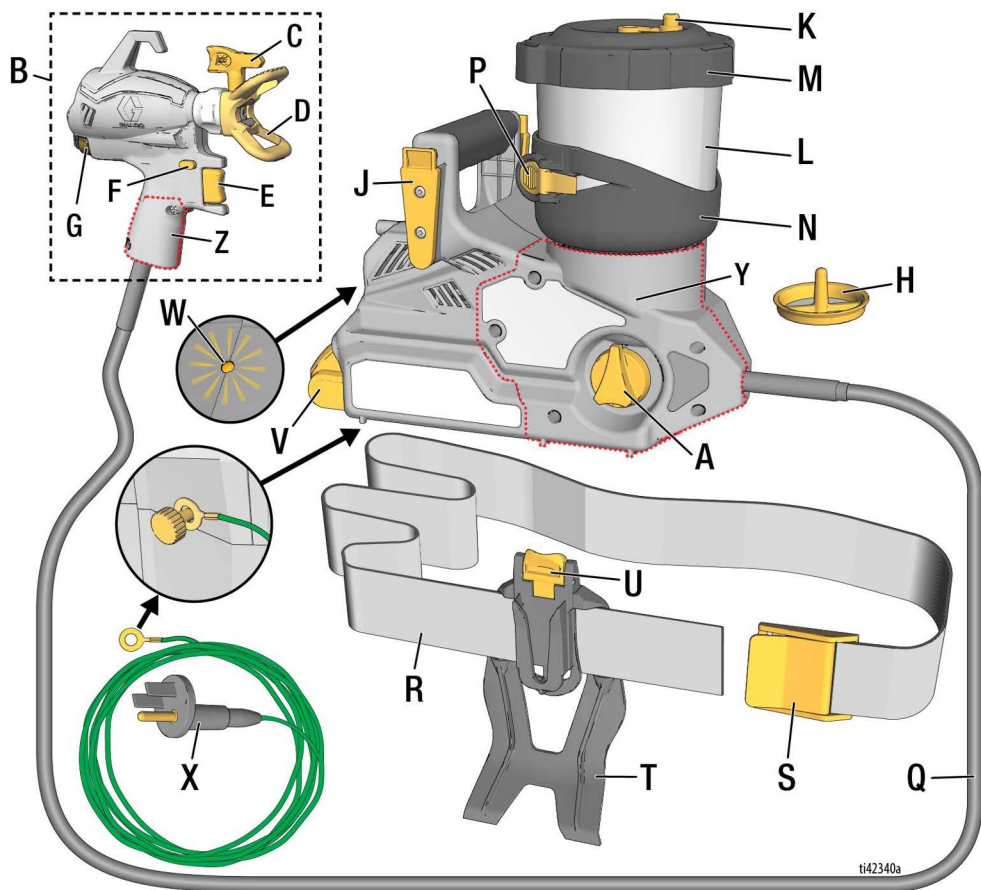

ti42340a

A	Prime Knob
B	Spray Gun
C	Spray Tip (2 included)
D	Spray Tip Guard
E	Trigger
F	Trigger Lock
G	Flow Control
H	Pump Filter (2 included)
J	Belt Clip (on sprayer)
K	Storage Plug (2 included)
L	Cup
M	Cup Lid

N	Cup Support
P	Cup Release Lever
Q	Hose
R	Belt
S	Belt Latch
T	Belt Holster
U	Holster Release Clip
V	Battery
W	Diagnostic Light
X	Grounding Wire and Plug
Y	ProConnect Access Door, Sprayer
Z	ProConnect Access Door, Gun

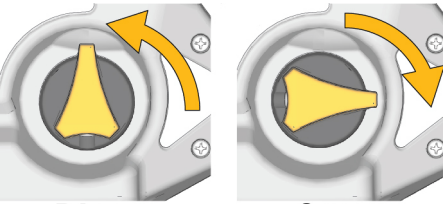
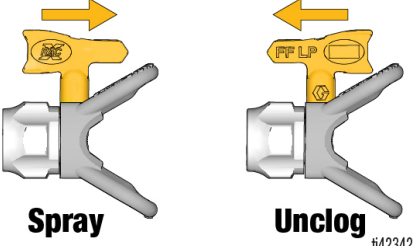
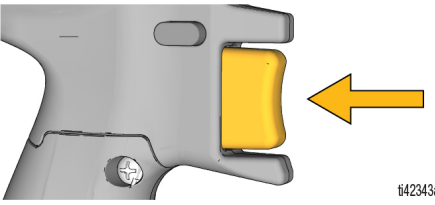
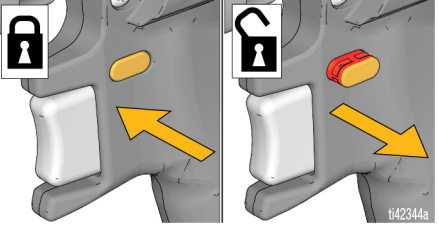
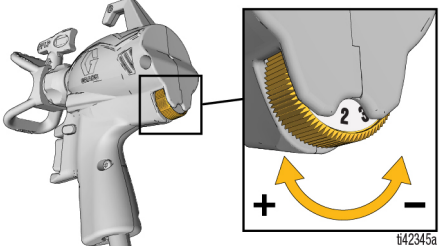

## Know Your Controls

 <p><b>Prime</b> <b>Spray</b></p>	<p><b>Prime Knob</b> The Prime Knob directs fluid to either the Cup or the Spray Tip. When priming, it is used to purge air from the pump. Your sprayer will not spray with air in the pump.</p> <p>Turn Prime Knob up to PRIME position when priming the sprayer or to relieve system pressure.</p> <p>Turn Prime Knob forward to SPRAY position to spray fluid.</p>
 <p><b>Spray</b> <b>Unclog</b></p>	<p><b>Spray Tip</b> The Spray Tip is the key to airless spray technology. High pressure paint pumped through the very small hole in the Spray Tip comes out as a spray.</p> <p>The Spray Tip has the ability to be reversed and quickly clear clogs.</p>
 <p><b>Trigger</b></p>	<p><b>Trigger</b> The Trigger controls the operation of the sprayer.</p>
 <p><b>Trigger Lock</b></p>	<p><b>Trigger Lock</b> The Trigger Lock prevents the Spray Gun from spraying when engaged and allows the gun to spray when disengaged.</p> <p>When the Trigger Lock is engaged, there is no visible red showing on the Trigger Lock. Engage Trigger Lock when not spraying.</p>
 <p><b>Flow Control</b></p>	<p><b>Flow Control</b> The Flow Control allows you to slow down or speed up when spraying.</p>

# Grounding Instructions

## Grounding Instructions

### (Oil-Based or Flammable Materials)



The equipment must be grounded to reduce the risk of static sparking. A static spark can cause fumes to ignite or explode. A good ground provides an escape wire for the electric current.

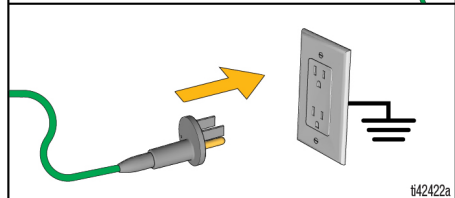
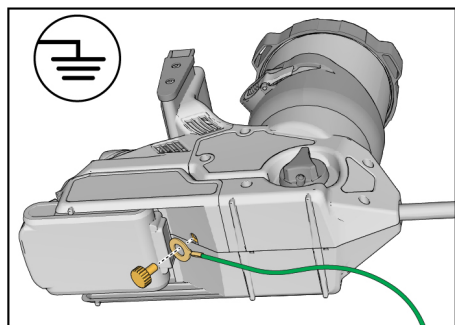

The sprayer is equipped with a Ground Wire and Plug. The Plug must be connected to a properly grounded electrical outlet when spraying or flushing oil-based or flammable materials, see **Important Grounding Information**, page 4. Move the sprayer away from the spray area when connecting the Ground Wire and Plug.

If the Grounding Wire is not long enough to reach a grounded electrical outlet, use a 3-wire grounded extension cord between the Plug and outlet.

## Pails

**Oil-based or flammable fluids:** follow local codes and regulations. Use only conductive metal pails, placed on a grounded surface such as concrete.

Do not place pail on a non-conductive surface such as paper or cardboard which interrupts grounding continuity.



**Always ground a metal pail:** connect a ground wire to the pail. Clamp one end to the pail and the other end to a true earth ground such as a water pipe.

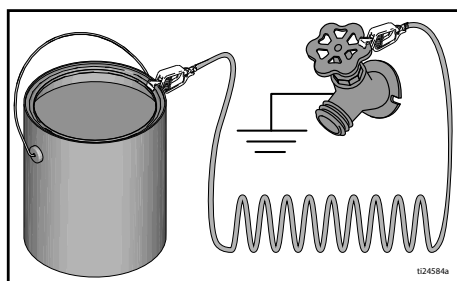

# Setup

## Pressure Relief Procedure



This sprayer builds up an internal pressure of 2000 psi (138 bar, 14 MPa) during use. Follow the **Pressure Relief Procedure** whenever you stop spraying and before cleaning, checking, servicing, or transporting equipment to prevent serious injury from pressurized fluid.

1. Turn Prime Knob up to PRIME position to relieve system pressure.

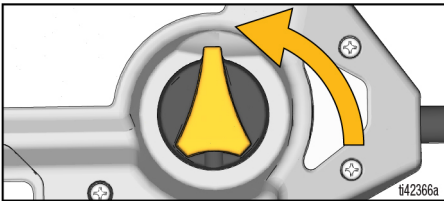

2. Hold metal tip guard nut firmly to a grounded metal pail. Point Spray Gun into pail, disengage Trigger Lock, and trigger the Spray Gun to relieve system pressure.

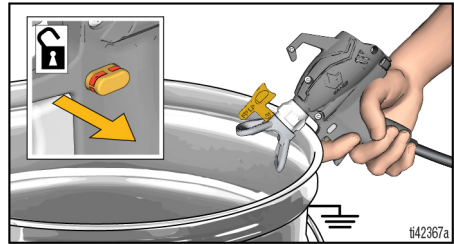

**NOTE:** Leave Prime Knob in the PRIME position until you are ready to spray.

### NOTICE

To avoid damage, never immerse the electronic Spray Gun in water or other fluid.

# Setup

## Sprayer Setup



Flammable fumes (such as solvent and paint fumes) in work area can ignite or explode.

See **Grounding Instructions**, page 10.

Do not spray flammable or combustible liquids in a confined area. When spraying flammable or combustible materials:

- Move entire sprayer to a well-ventilated area and away from flammable or combustible materials, including paints and solvents when refilling.
- Keep material containers covered between Cup refills.

If spraying **oil-based or flammable materials**, review **Cleaning Fluid Compatibility**, page 26 and follow **Grounding Instructions**, page 10.

**NOTE:** It is recommended to always pre-strain the paint prior to filling the cup.

1. Engage Trigger Lock. Turn Prime Knob up to PRIME position.
2. Remove Cup Lid from the Cup.



3. Verify a clean Pump Filter is installed in the bottom of the Cup at the pump inlet. Use the black, 60 mesh filter with paints and the blue, 100 mesh filter with stains and thin materials.

**NOTE:** A dirty or plugged Pump Filter will result in poor sprayer operation or loss of prime.

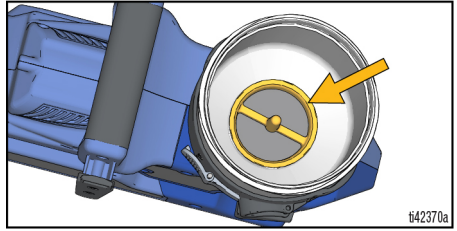

4. Fill Cup with paint and reinstall Cup Lid.

**NOTE:** Do NOT shake materials to be used with this sprayer. Some fine finish lacquers and enamels trap air when shaken, which can affect sprayer performance. Stir the material or check the manufacturer's recommendation for the material being sprayed.

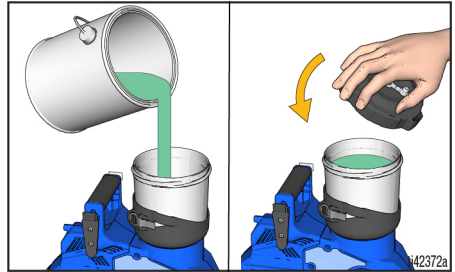

**NOTE:** Use of the Storage Plug on top of the Cup Lid is optional. Storage Plug must be open while spraying to avoid an air lock and loss of prime.

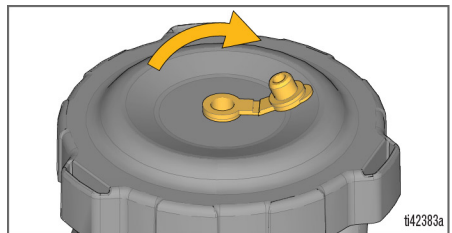

## Belt Setup

1. Install Belt Holster onto Belt located per the user's preference (left side, right side, or back side).

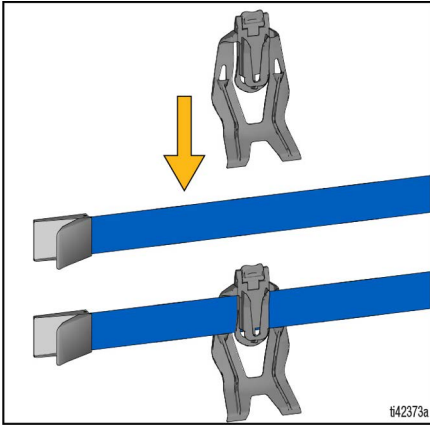

2. Attach the Belt on waist and tighten until snug. Close Belt Latch.

**NOTE:** It is recommended to tighten the belt fairly tight to ensure the sprayer is held securely during use.

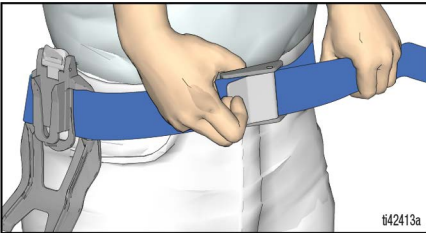

3. Attach sprayer to Belt Holster in orientation of the user's preference (Hose facing forward or backward).

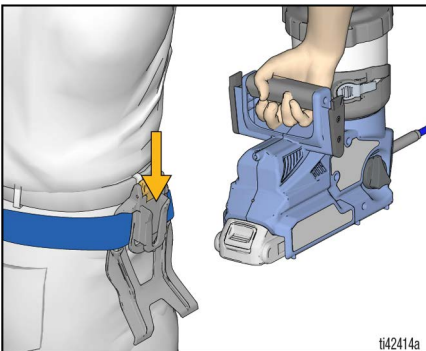

4. Spray Gun will hook on the outside of the sprayer as shown for hands-free mobility.

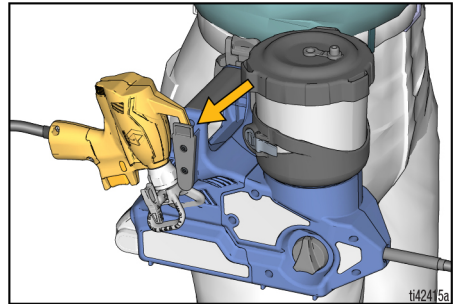

5. To remove sprayer from Belt, press the Holster Release Clip and pull up on the sprayer.

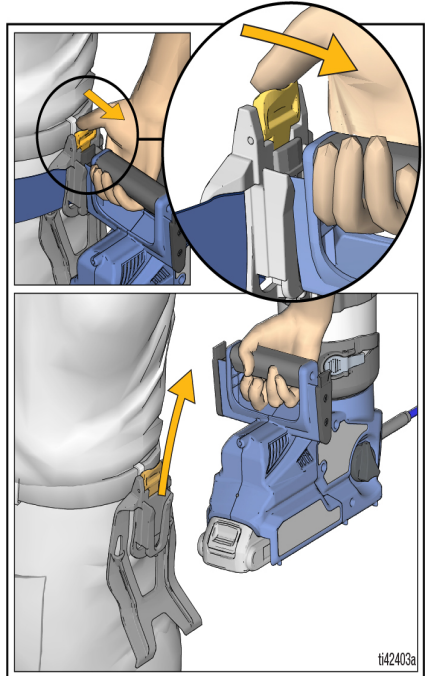



**NOTE:** Extra Belt length can be cut to desired size with scissors.

### NOTICE

Never pull the sprayer around by the Hose. Doing so can disconnect the wire connections in the sprayer or Spray Gun.

## Startup

**Always start with a fully charged Battery. Do not splash or immerse Battery or charger in water or solvents. See Battery and charger information shipped with the sprayer.**

				
Replace and charge Battery only in a well-ventilated area and away from flammable or combustible materials, including paints and solvents.				

1. Disengage Trigger Lock and verify Prime Knob is pointed up in the PRIME position.

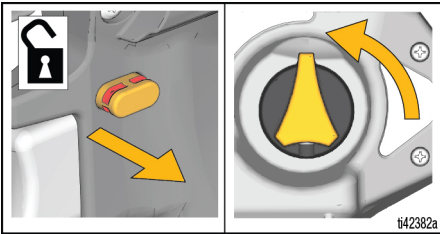

2. Turn the Spray Tip to UNCLOG position.

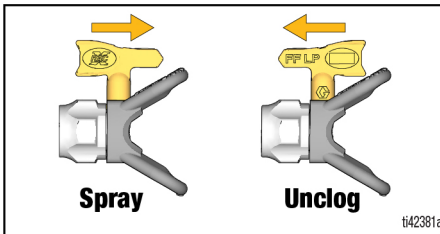

3. Install fully charged Battery onto sprayer.

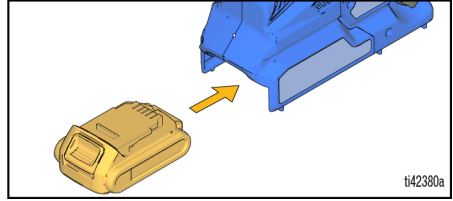

4. Verify Storage Plug is OPEN.

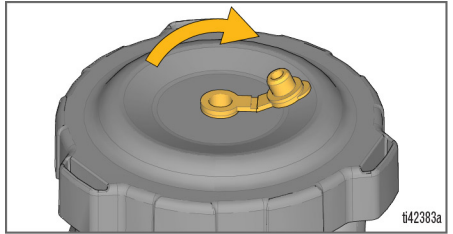

5. To prime the pump, point the Spray Gun into a waste pail and pull the Trigger for 10 seconds. This will purge air from the pump.

**NOTE:** The electronic Spray Gun is always open when the Trigger is pulled so a small amount of fluid may spray out while priming.

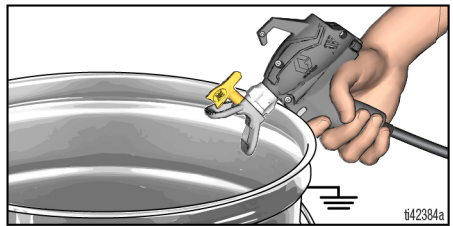

- Turn the Prime Knob forward to SPRAY position.

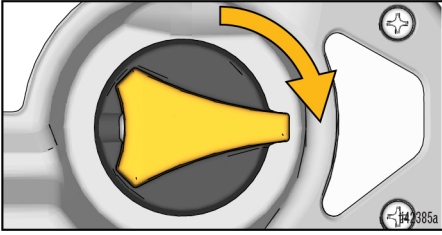

- To prime the Hose and Spray Gun, point the Spray Gun into a waste pail and pull the Trigger for 10 seconds or until there is a steady stream of paint. This will purge air (and storage fluid) from the Hose and Gun.

**NOTE:** To avoid pump damage, if the sprayer does not spray after 10 seconds, STOP and repeat STARTUP.

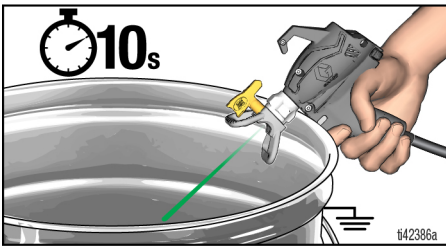

- Turn the Spray Tip forward to SPRAY position.

**You are now ready to spray!**

# Spraying

## Spraying



Take a few moments prior to spraying and review these simple tips to ensure your spraying project is a success.

**NOTE:** For proper spraying operation use only Graco FFLP family of tips with your Spray Gun.

## Flow Control

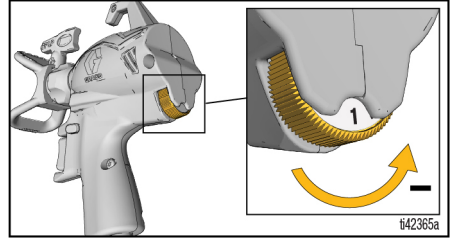

The Flow Control allows for precise pressure adjustment. To reduce overspray, always start at lowest speed setting and increase speed to the minimum setting that results in an acceptable spray pattern.

## Tip and Pressure Selection

See table below for general recommendations for Spray Tip sizes and Flow Control settings for materials. Also refer to paint (material) can for manufacturer's recommendations.

	Materials					
	Interior Stains/ Interior & Exterior Clears	Exterior Solid Stains	Enamels	Primers	Interior Latex Paints	Exterior Latex Paints
<b>Flow Control</b>	1 – 4	4 – 8	4 – 10	6 – 10	6 – 10	6 – 10
Tip hole Size						
0.008 in. (0.20 mm)	✓	✓	✓			
0.010 in. (0.25 mm)	✓	✓	✓			
0.012 in. (0.30 mm)	✓	✓	✓			
0.014 in. (0.36 mm)		✓	✓	✓	✓	✓
0.016 in. (0.41 mm)			✓	✓	✓	✓

## Spray Tip Orientation



To avoid serious injury from skin injection, do not put your hand in front of the Spray Tip or Spray Tip Guard.

1. Engage the Trigger Lock.

2. Adjust the Spray Tip Guard for the desired vertical or horizontal spraying direction.

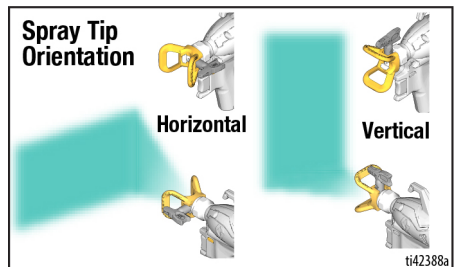



## Spray Techniques

Use a piece of scrap cardboard to practice these basic spraying techniques before you begin spraying the surface.

- Hold Spray Gun 12 in. (30 cm) from surface and aim straight at surface. Tilting the Spray Gun to direct the spray angle causes an uneven finish.
- Flex wrist to keep Spray Gun pointed straight. Fanning Spray Gun to direct spray angle causes uneven finish.

**NOTE:** How fast you move the Spray Gun will affect spray application. If material is uneven, you are moving too fast. If material drips, you are moving too slow. See **Troubleshooting**, page 28.

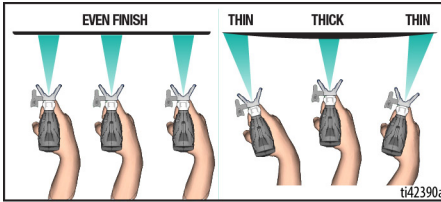
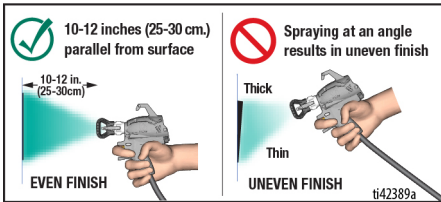

## Aiming Spray Gun

Aim the Spray Gun at the bottom edge of the previous stroke, overlapping each stroke by 50%.

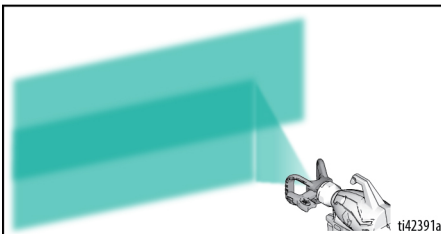

## Triggering Timing

Pull Trigger after starting stroke. Release Trigger before end of stroke. Spray Gun must be moving when Trigger is pulled and released.

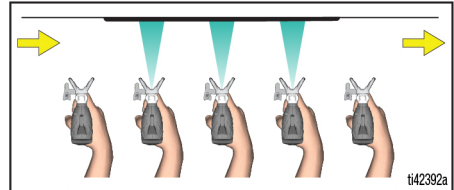

## Spray Pattern Quality

A good spray pattern is evenly distributed as it hits the surface.

- Spray should be atomized (evenly distributed, no gaps at edges).

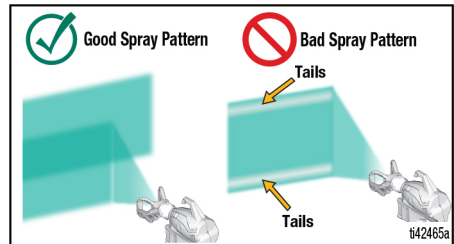

If tails persist when spraying at the highest spray pressure:

- Spray Tip may be worn. See **Tip and Pressure Selection**, page 16.
- A smaller Spray Tip may be needed.
- Material may need to be thinned. Follow manufacturers recommendations.

# Spraying

## Clear Tip Clogs



To avoid serious injury from skin injection, do not put your hand in front of the Spray Tip or Spray Tip Guard.

1. Release Trigger. Engage Trigger Lock. Rotate Spray Tip to UNCLOG position. Disengage Trigger Lock. Trigger Spray Gun into waste pail to clear clog.

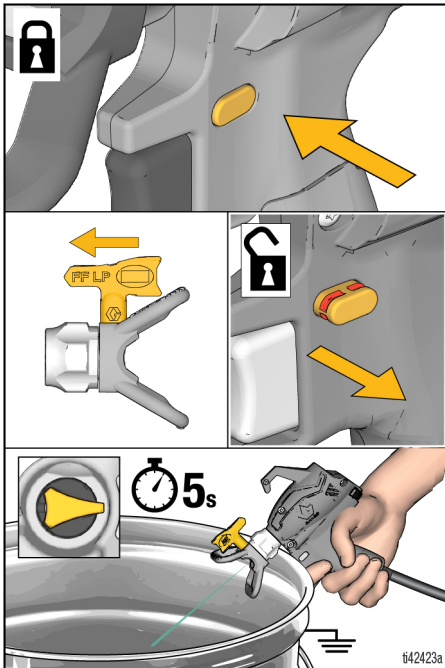

2. Engage Trigger Lock. Return Spray Tip to SPRAY position. Disengage Trigger Lock and continue spraying.

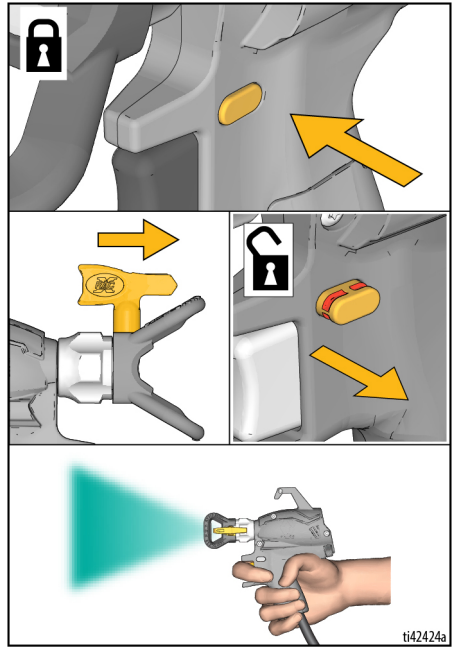

**NOTE:** If Spray Tip is still clogged, repeat steps 1 and 2 with Flow Control set to 10. If still plugged you may have to replace the Spray Tip.

## Spray Tip Installation



To avoid serious injury from skin injection, do not put your hand in front of the Spray Tip when installing or removing the Spray Tip and Spray Tip Guard.

**NOTE:** For proper spraying operation use only Graco FFLP family of tips with your Spray Gun.

1. Perform **Pressure Relief Procedure**, page 11.
2. Remove Battery from sprayer.
3. Use Spray Tip (A) to insert OneSeal™ (B) into Spray Tip Guard (C).

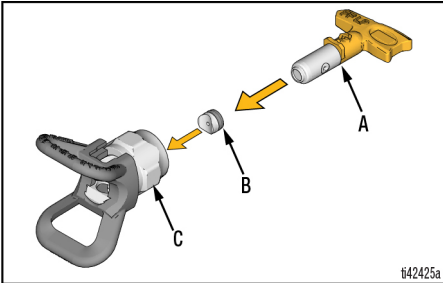

4. Insert Spray Tip into Spray Tip Guard.

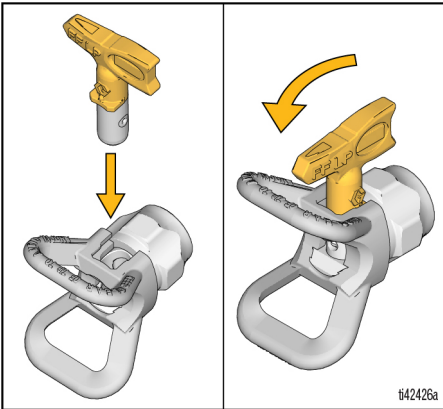



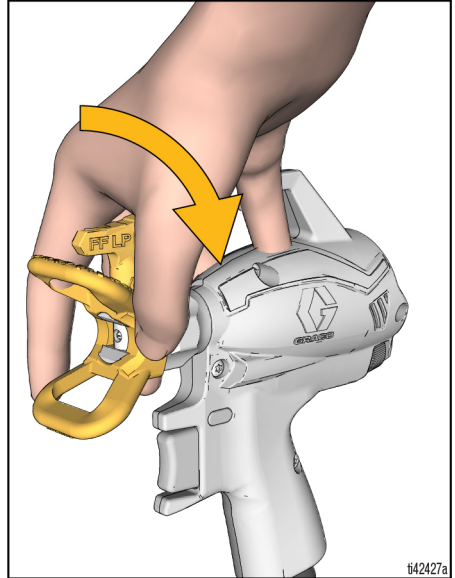

5. Screw assembly onto Spray Gun and hand tighten.

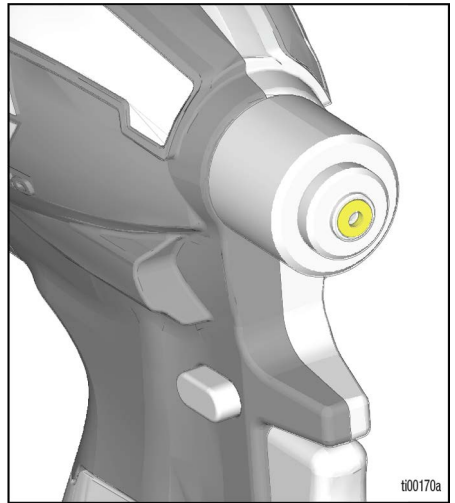

**NOTE:** The Spray Gun has an integrated solvent gasket in the end of the gun (yellow). This allows for the use of the standard OneSeal™ (B) for all material applications.



## Cup Refills

				
--	---	---	---	--

Flammable fumes (such as solvent and paint fumes) in work area can ignite or explode.

See **Grounding Instructions**, page 10.

Do not spray flammable or combustible liquids in a confined area. When spraying flammable or combustible materials:

- Move entire sprayer to a well-ventilated area and away from flammable or combustible materials, including paints and solvents when refilling.
- Keep material containers covered between Cup refills.

Cup refills can be performed while wearing the sprayer on the Belt or after removing the sprayer from the Belt and setting it on a flat surface.

1. Engage Trigger Lock. Turn the Prime Knob up to PRIME position to relieve system pressure.

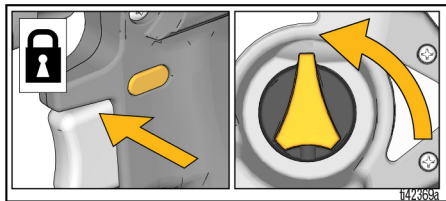

2. If desired, remove sprayer from the Belt by pressing the Holster Release Clip and pulling up on the sprayer.

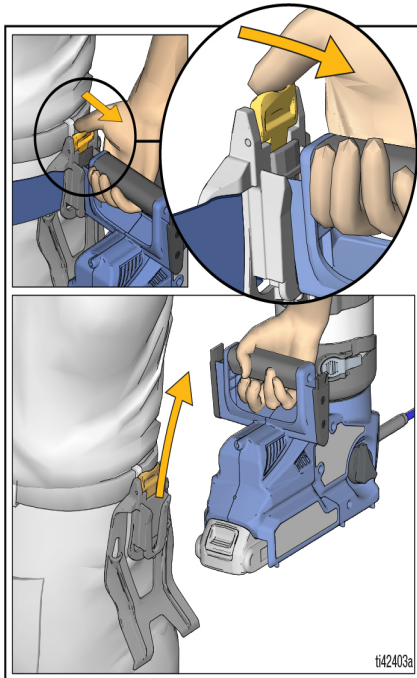

3. Remove the Cup Lid from the Cup.

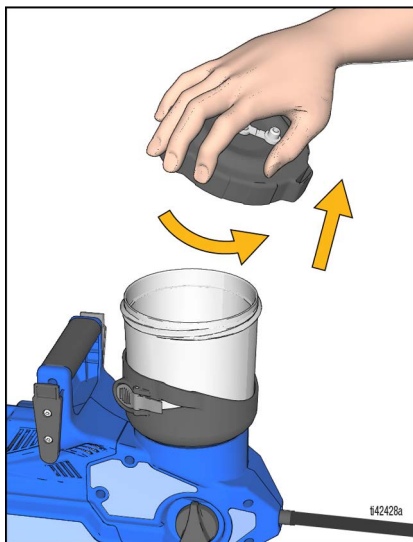

**NOTE:** The Cup Lid hooks onto the sprayer while refilling the Cup.

## Pause in Spraying

Paint will dry quickly and cause clogs in the sprayer. Follow these steps whenever you pause spraying for 5 minutes to 2 hours.

1. Engage Trigger Lock and remove Battery from sprayer.
2. Turn Prime Knob up to PRIME position to relieve system pressure.
3. Turn Spray Tip 90 degrees to seal orifice from drying out.

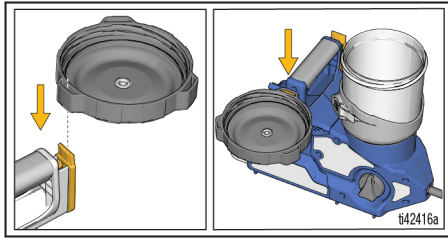

4. Remove the Pump Filter and clean debris from the filter screen.

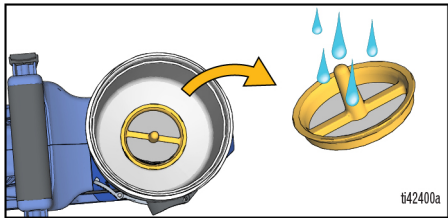

5. Reinstall Pump Filter in the bottom of the Cup.

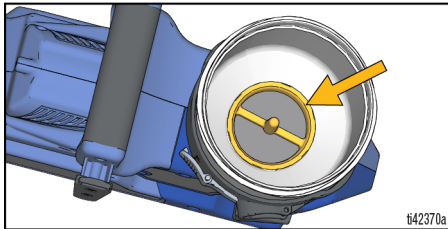

6. Refill the Cup with paint and reinstall Cup Lid.

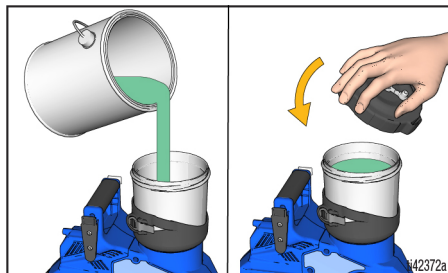

7. Follow **Startup** instructions, page 14, to proceed.

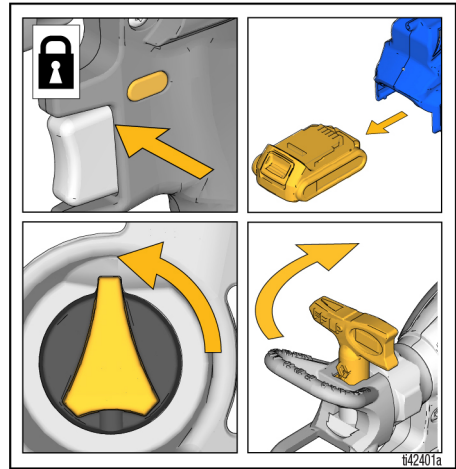

4. Close Storage Plug in Cup Lid to seal material in Cup.

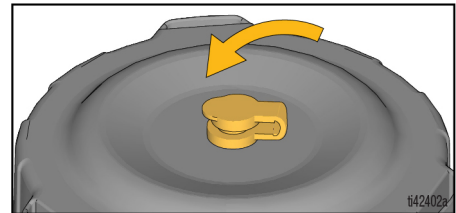

### NOTICE

To avoid damage, never immerse the electronic Spray Gun in water or other fluid.

## Cleanup

### NOTICE

Failure to properly clean sprayer after each use will result in hardened materials, damage to the sprayer, and the warranty will no longer be valid. Do not store solvents other than mineral spirits in sprayer. Always flush with Graco Pump Armor prior to storage.

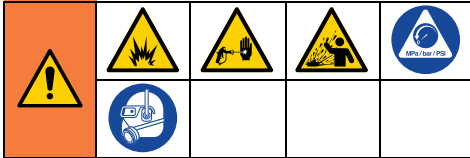

To avoid serious injury from fire and explosion when using oil-based or flammable materials:

- Do not spray solvents through the spray tip. Always remove tip guard and spray tip before flushing. Clean tip guard and spray tip in a bucket of compatible solvent.
- Clean in a well-ventilated area. Keep a good supply of fresh air moving through the area.
- When flushing with solvents, always ground the sprayer and waste container.

See **Cleaning Fluid Compatibility**, page 26 and **Grounding Instructions**, page 10 for additional information when using oil-based or flammable materials.

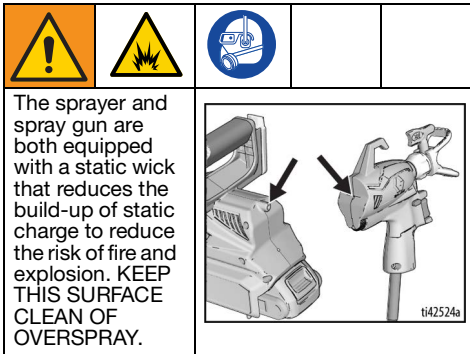

## Cleaning Sprayer

1. Engage Trigger Lock.

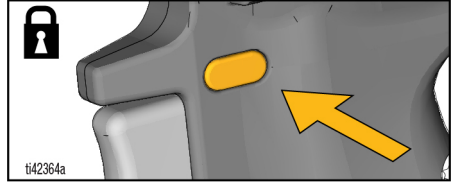

2. Turn Prime Knob up to PRIME position to relieve system pressure.

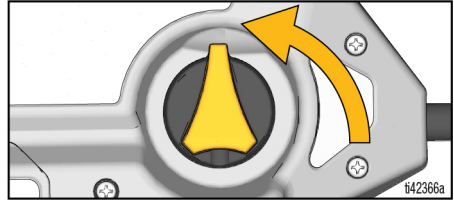

3. Remove sprayer from the Belt by pressing the Holster Release Clip and pulling up on the sprayer.

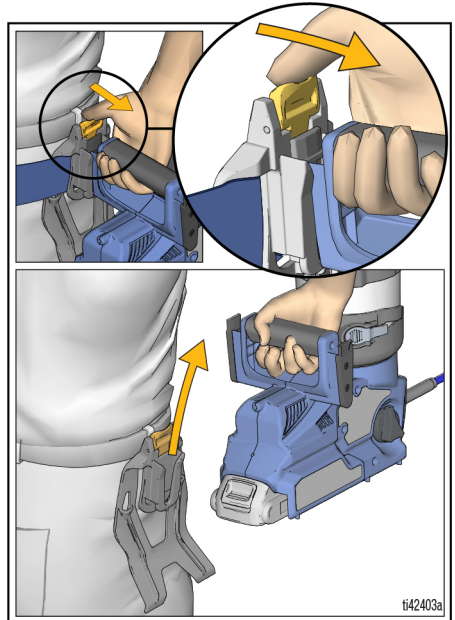

4. Remove Cup Lid and pour extra paint back into paint can.

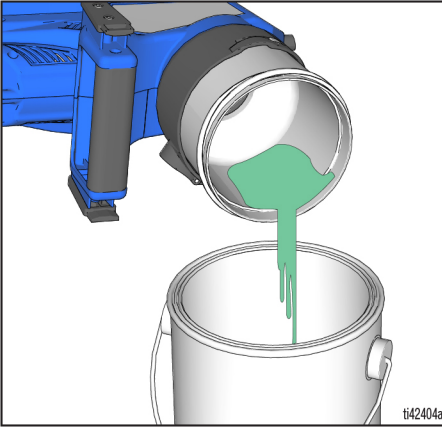

**NOTE:** Always clean sprayer with a clean filter installed to prevent debris from lodging in the pump or Spray Gun.

5. Remove Pump Filter and clean debris from both sides of the filter screen.

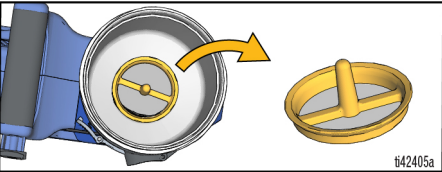

6. Reinstall Pump Filter in the bottom of the Cup.

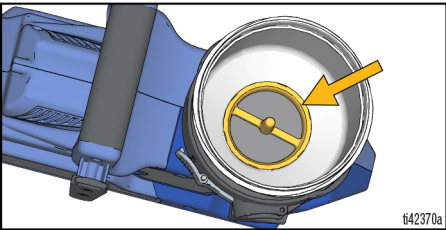

7. Fill Cup half-full of cleaning fluid, see **Cleaning Fluid Compatibility**, page 26, and reinstall Cup Lid. Verify Storage Plug is OPEN.
- a. Verify the Prime Knob is pointed up in the PRIME position and turn Spray Tip to the UNCLOG position.
  - b. Disengage Trigger Lock and turn Flow Control to 10.
  - c. Point Spray Gun into a waste pail and trigger for 15 seconds to circulate cleaning fluid through the pump.

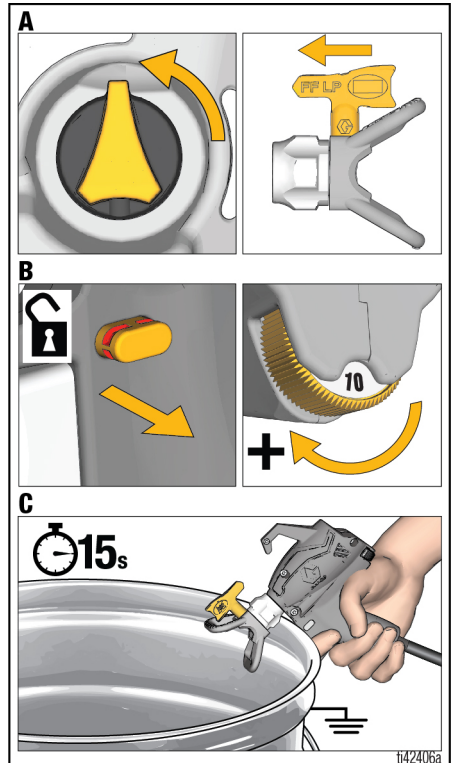

# Cleanup

## 8. Spray cleaning fluid:

- Turn Prime Knob forward to SPRAY position and verify Spray Tip is in the UNCLOG position.
- Point Spray Gun into a waste pail and trigger until cleaning fluid is emptied from the Cup.

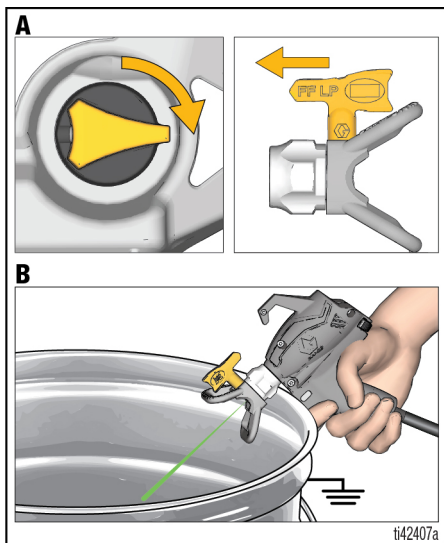

## 9. Verify Cup is empty and remove Cup from sprayer by depressing the Cup Release Lever and rotating Cup out of the Cup Support.

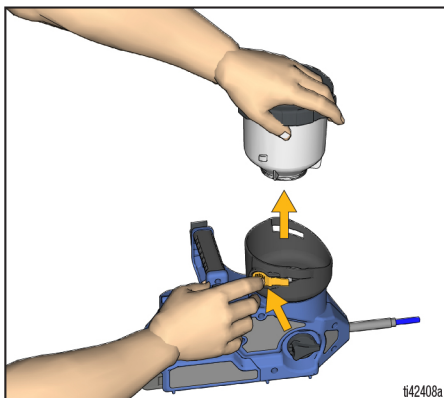

- Clean Cup, Cup Lid and Pump Filter in warm water.
- Wipe out Cup Support with wet rag. Reinstall Cup, Pump Filter and Cup Lid back into the Cup Support.
- Repeat steps 6 and 7 as needed until sprayer is clean. Repeat steps 6 and 7 as needed until sprayer is clean.
- Before storage, circulate and spray a small amount of Pump Armor Storage Fluid.
- Engage Trigger Lock. Turn Prime Knob up to PRIME position.

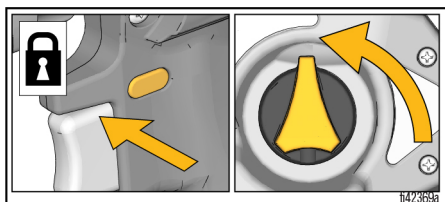

## 15. Remove Battery.

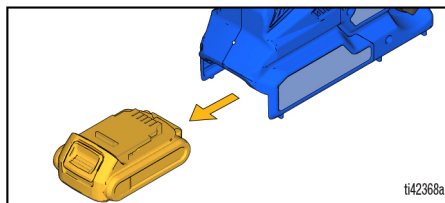

- Remove Spray Tip and Spray Tip Guard.
- Clean Spray Tip and Spray Tip Guard with warm water and an old toothbrush. Reinstall Spray Tip and Spray Tip Guard.
- Turn Spray Tip 90 degrees for storage and CLOSE Storage Plug on Cup Lid.



# Storage

## NOTICE

Failure to store sprayer with Pump Armor can result in operational problems the next time you spray. Always circulate Pump Armor through the sprayer after cleaning. **Water or solvents other than mineral spirits left in the sprayer will corrode and damage the pump.**

Pump Armor fluid protects the sprayer while in storage. It helps protect sprayer against startup issues on next use.

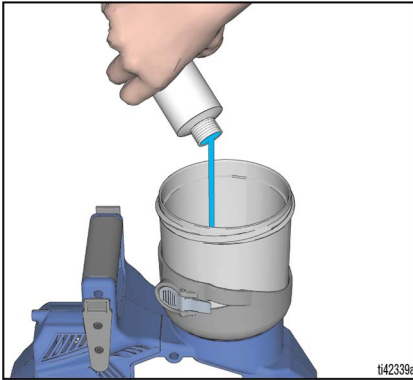







## Storage

- Circulate and spray a small amount of Pump Armor Storage Fluid.
- Engage Trigger Lock
- Turn Prime Knob to PRIME position.
- Remove Battery, Spray Tip and Spray Tip Guard.
- Clean Spay Tip and Spray Tip Guard with warm water and an old tooth brush, and reinstall onto gun.
- Turn Spray Tip 90 degrees for storage, and CLOSE Storage Plug on Cup Lid.
- Do not store the sprayer full of water.
- Do not allow water to freeze in sprayer.
- Do not store sprayer under pressure.
- Store sprayer indoors in a cool, dry location.
- Never store sprayer with material in the sprayer or Cup.

## Reference

### Cleaning Fluid Compatibility

#### Oil-Based or Flammable or Water-Based Materials

- When spraying **water-based** materials, flush the system thoroughly with water.
- When spraying **oil-based or flammable** materials, flush the system thoroughly with mineral spirits or compatible, flushing solvent.
- To spray **water-based** materials **after spraying oil-based or flammable** materials, flush the system thoroughly with water first. The water flowing out of drain tube should be clear and solvent-free **before** you begin spraying the water-based material.
- To spray **oil-based or flammable** materials **after spraying water-based** materials, flush the system thoroughly with mineral spirits or a compatible flushing solvent first. The solvent flowing out of the drain tube should not contain any water. When flushing with solvents always follow **Cleaning Sprayer**, page 22.
- To avoid fluid splashing back on your skin or into your eyes, always aim gun at inside wall of pail.

## Recycling and Disposal

### End of Product Life

At the end of the product's useful life, dismantle and recycle it in a responsible manner.

- Perform **Pressure Relief Procedure**, page 11.
- Drain and dispose of fluids according to applicable regulations. Refer to the material manufacturer's Safety Data Sheet.
- Remove motors, batteries, circuit boards, LCDs (liquid crystal displays), and other electronic components. Recycle according to applicable regulations.
- Do not dispose of electronic components with household or commercial waste. 
- Deliver remaining product to a recycling facility.

## California Proposition 65

### CALIFORNIA RESIDENTS

 **WARNING:** Cancer and reproductive harm – [www.P65warnings.ca.gov](http://www.P65warnings.ca.gov).

## Troubleshooting



Check everything in this Troubleshooting Table before you bring the sprayer to an authorized service center.



### Sprayer Diagnostics



Problem	Cause	Solution
Sprayer makes no sound when Trigger is pulled	Diagnostic Light blinks two times when Trigger is pulled. Indicates incorrect voltage.	Replace Battery with a charged Battery. Battery has reached end of life. Replace the Battery.
	Diagnostic Light blinks three times when Trigger is pulled. Indicates Battery temperature is too hot or cold.	Allow Battery to cool down or warm up to room temperature.
	Diagnostic Light blinks four times when Trigger is pulled. Indicates locked rotor condition.	Replace pump and/or motor assembly.
	Diagnostic Light does not blink when Trigger is pulled. Indicates Battery is not installed or is damaged.	Install Battery or replace Battery. Replace Smartcontrol.
	Electronic hose connections are not connected.	Ensure electronic wire connectors are tight at both ends of the hose inside the sprayer and gun ProConnect access doors.
	Hose wires are damaged.	Replace Hose.
	Spray Gun internals are wet.	Shake Spray Gun and allow to dry for 10 minutes. Open gun ProConnect access door and pull apart wire connector and allow to fully dry for several hours.
Sprayer makes sound but no material is sprayed when Trigger is pulled.	Sprayer is not primed.	Repeat <b>Startup</b> , page 14.
	No air allowed into Cup.	Make certain the Storage Plug on the Cup Lid is open when spraying.
	Debris in paint, dirty Pump Filter	Clean sprayer, see <b>Cleanup</b> , page 22, and clean pump filter. Strain your paint before filling Cup and repeat setup and startup.
	Prime Knob is in PRIME position.	Turn Prime Knob forward to SPRAY position.
	Spray Tip is not in SPRAY position.	Turn spray tip to SPRAY position.
	Spray Tip is clogged.	See <b>Clear Tip Clogs</b> , page 18.
	No or low material in Cup.	Refill Cup with paint.
	Debris stuck in Spray Gun or Pump.	See <b>Advanced Troubleshooting</b> , page 32.
	Pump has reached the end of its life.	Replace pump assembly.
	Hose is plugged.	Replace Hose.
	Hose wires are damaged.	Replace Hose.
	Spray Gun has reached end of life.	Replace Spray Gun.

Problem	Cause	Solution
Sprayer sprays with poor results	Flow Control is set too low.	Increase speed until an acceptable pattern is achieved.
	No air allowed into Cup.	Make certain the Storage Plug on the Cup Lid is open when spraying.
	Spray Tip is partially clogged.	See <b>Clear Tip Clogs</b> , page 18.
	Spray Tip is not in correct position.	Rotate spray tip to SPRAY position.
	Incorrect Spray Tip for application of material.	Install different size Spray Tip. See <b>Tip and Pressure Selection</b> , page 16.
	Spray Tip is worn or damaged.	Replace Spray Tip. See <b>Tip and Pressure Selection</b> , page 16.
	Material being sprayed is aerated because it was shaken.	Do <b>NOT</b> shake material. Stir the material or check the manufacturer's recommendation for the material being sprayed.
	Material being sprayed is too cold to spray.	Warm material.
	Material being sprayed is incompatible with sprayer.	Fully clean system. See <b>Cleanup</b> , page 22. Try thinning the material per manufacturer's recommendation, or switch to a different material.
	Gasket on front of Spray Gun is damaged or lost.	Replace gasket.
	Debris stuck in Spray Gun or Pump	See <b>Advanced Troubleshooting</b> , page 32.
	Hose wires are damaged.	Replace Hose.
	Spray Gun has reached end of life.	Replace Spray Gun.
Pump has reached end of life.	Replace pump assembly.	
Pump will spray paint but will not spray water.	Prime valve leaking.	Replace prime valve.
	Battery has insufficient charge.	Charge Battery.
	Pump has reached the end of its life.	Replace pump assembly.

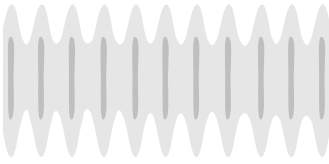
# Troubleshooting

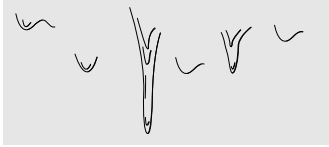
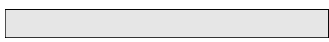
## Spray Pattern Diagnostics

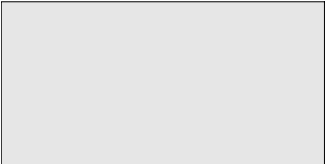
Problem	Cause	Solution
Spray pattern is uneven: 	Operator is moving too fast while spraying.	Slow speed of movement.
	Spray tip is clogged.	Unclog spray tip or clean spray tip see <b>Clear Tip Clogs</b> , page 18.
	Material difficult to atomize.	Increase speed until desired pattern is achieved.
		Hold sprayer farther away from surface.
	Switch to different spray tip. See <b>Tip and Pressure Selection</b> , page 16.	
Outlet valves are dirty or worn.	Remove two pump plugs and front valve to gain access to the three outlet valves. Clean outlet valves. Replace if necessary.	
	Pump has reached the end of its life.	Replace pump assembly.
Spray pattern has tails: 	Speed control is set too low.	Increase speed until desired pattern is achieved.
	Material may need to be thinned.	Thin material follow paint manufacturer's recommendations.
	Incorrect spray tip for application of material.	Install different size spray tip. See <b>Tip and Pressure Selection</b> , page 16.
	Material not compatible with sprayer.	Switch material.
	Spray tip is worn or damaged.	Replace spray tip. See <b>Spray Tip Installation</b> , page 19.
Spray pattern has dripping/sagging: 	Operator is moving too slowly while spraying.	Move sprayer faster while spraying.
	Sprayer is too close to target surface.	Move sprayer away from surface 10 in. (25 cm)
	Holding trigger while changing spray direction.	Release trigger when changing directions.
	Speed control switch is set too high.	Decrease speed until desired pattern is achieved.
	Spray tip is worn or damaged.	Replace spray tip. See <b>Spray Tip Installation</b> , page 19.
Spray pattern is too narrow: 	Sprayer is too close to target surface.	Move sprayer away from surface 10 in. (25 cm)
	Incorrect spray tip for application of material.	Install different size spray tip. See <b>Spray Tip Installation</b> , page 19.
	Spray tip is worn or damaged.	Replace spray tip. See <b>Spray Tip Installation</b> , page 19.

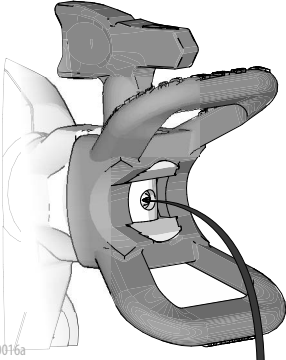
Problem	Cause	Solution
<p>Spray pattern is too wide:</p> 	<p>Sprayer is too far away from target surface.</p>	<p>Move sprayer closer to surface.</p>
	<p>Incorrect spray tip for application of material.</p>	<p>Install different size spray tip. See <b>Spray Tip Installation</b>, page 19.</p>
<p>Spray pattern “spits” at the beginning or end of pattern:</p> 	<p>Excess material has accumulated on spray tip guard assembly or spray tip is partially clogged.</p>	<p>Clean spray tip guard. See <b>Clear Tip Clogs</b>, page 18.</p>
	<p>Spray tip not inserted completely into spray tip guard.</p>	<p>See <b>Spray Tip Installation</b>, page 19.</p>
	<p>Spray tip is worn.</p>	<p>Replace spray tip. See <b>Spray Tip Installation</b>, page 19.</p>
	<p>Sprayer is dirty</p>	<p>Flush sprayer.</p>
	<p>Front valve has reached the end of its life.</p>	<p>Replace front valve assembly.</p>
<p>Spray tip continues to drip or ooze material after trigger is released:</p> 	<p>Spray tip is worn.</p>	<p>Replace spray tip. See <b>Spray Tip Installation</b>, page 19.</p>
	<p>Spray tip not inserted completely into spray tip guard.</p>	<p>See <b>Spray Tip Installation</b>, page 19.</p>
<p>Material leaks around spray tip guard or spray tip handle</p>	<p>Spray tip seal and seat are damaged or not properly installed.</p>	<p>See <b>Spray Tip Installation</b>, page 19.</p>

## Advanced Troubleshooting

### Debris in Pump or Gun

#### High-Flow Rapid Flush

1. Perform **Cleanup**, page 22.
2. With a clean filter in Cup, fill Cup with warm water.
3. Turn Flow Control to setting #10.
4. Remove Spray Tip from Tip Guard.
5. Point Spray Gun into waste pail and trigger the gun approximately 10-15 times.
6. Replace Spray Tip in Tip Guard.

#### Clean Pump Outlet Check Valves

**NOTE:** This should ONLY be performed if all other Troubleshooting efforts have failed to give successful results.

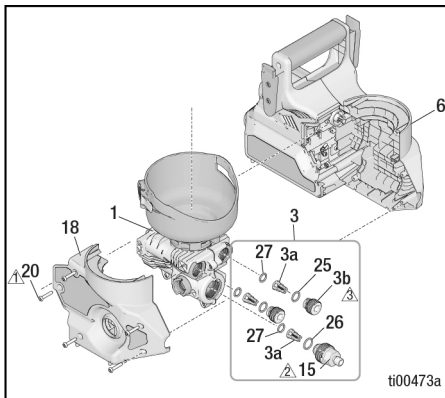

#### NOTICE

Do not use a power drill on the sprayer. Doing so can cause damage to the threads.

1. Perform **Pressure Relief Procedure**, page 11.
2. Remove Battery (24) from sprayer.
3. Remove cup assembly (10).
4. Turn Prime Knob (12) forward to spray position.
5. Remove cross-head screw (21) from Prime Knob (12) and remove knob.

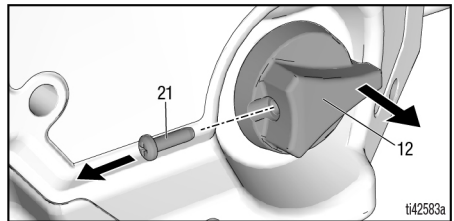

6. Remove five cross-head screws (20) from sprayer enclosure and remove enclosure cover (18).

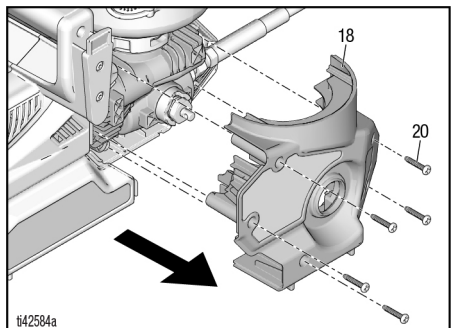



# Advanced Troubleshooting

7. Remove pump assembly (1) (with the hose) from SmartControl enclosure (6). Disconnect ground wire from pump assembly (1).

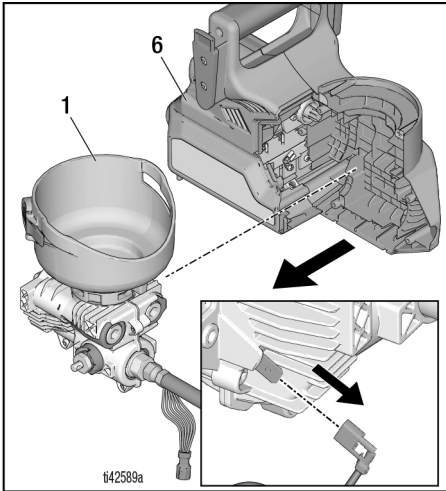

8. Disconnect electrical connectors. Remove hose (22) from hose adapter (15) using two wrenches.

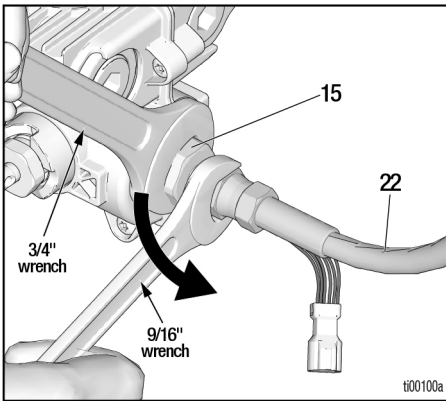

9. Remove two outlet valve plugs (3b) with 8mm (5/16") Allen wrench. Remove hose adapter (15) with 3/4" wrench. Remove three outlet valves (3a).

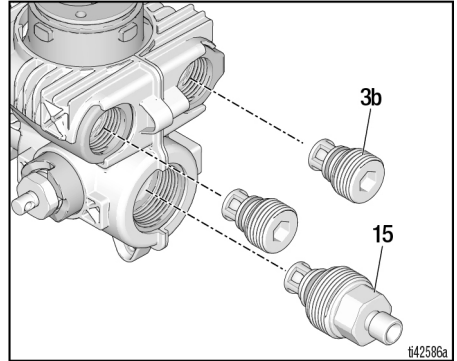

10. Clean three outlet valves of debris. Check to verify balls move freely against spring in the retainers.
11. Rinse open ports of pump under running water.

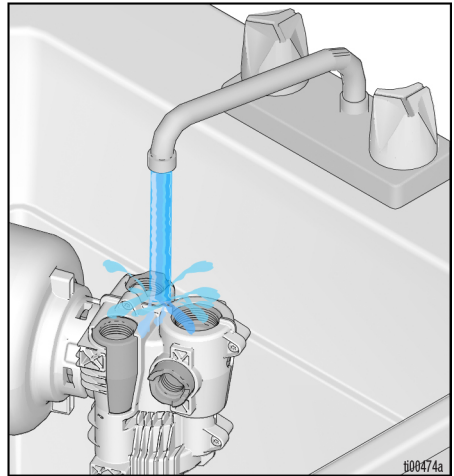

# Advanced Troubleshooting

12. Verify o-rings are present inside pump outlet ports, and flat against the bottom surface of each port. Use 8mm (5/16") Allen wrench to lightly push on the face of o-rings, if needed.

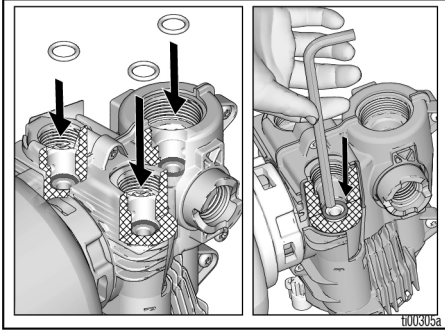

13. Install two outlet valve plugs (3b) and hose adapter (15). Use 8mm (5/16") Allen wrench to install outlet valve plugs. Torque hose adapter to 60 in-lb. Torque outlet valve plugs until snug (20 in-lb).
14. Using same two wrenches, attach hose (22) to hose adapter (15) of pump (1). Connect ground wire (A) to pump. Place pump assembly (1) into SmartControl enclosure (6), while making sure the pump gear meshes with the motor gear.

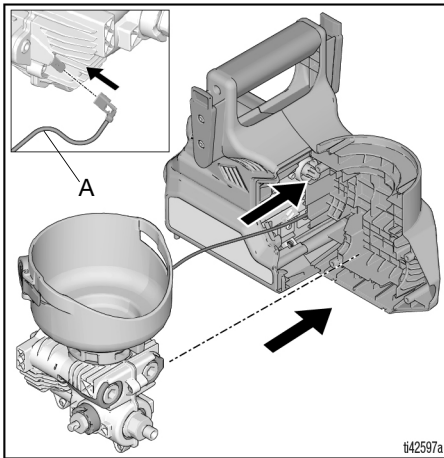

15. Connect electrical connectors.

**NOTE:** Push the connectors together gently, while keeping the connectors parallel to each other, until they click together.

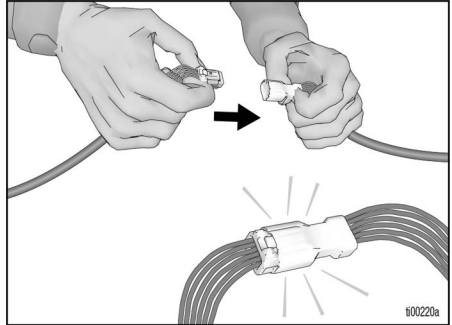

16. Before installing enclosure cover, ensure wires are laid securely in wire channels, away from pinch points such as screw bosses and between the enclosure seam.

## NOTICE

Failure to ensure wires are away from pinch points could cause the sprayer to become inoperable after assembled. Route the wires exactly as shown below.

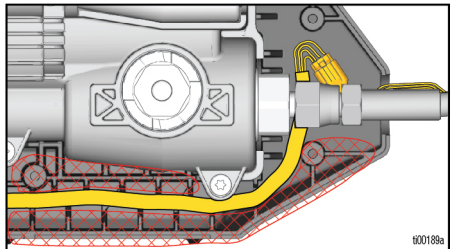

17. Install new enclosure cover (18). Secure with five cross-head screws (20). See **Replacement Parts**, page 36, for torques.

18. Rotate prime valve stem so the valve stem cross hole is oriented front to back along the length of the sprayer.

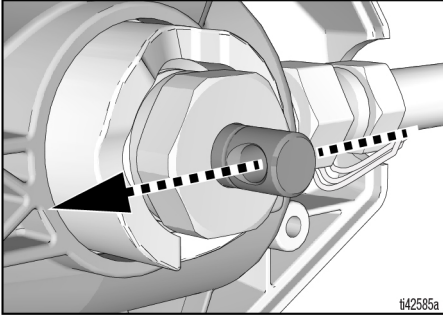

19. Install prime knob (12) so the knob is pointing forward. Install cross-head screw (21). See **Replacement Parts**, page 36, for torques.

**NOTE:** The knob (12) will only rotate forward and up.

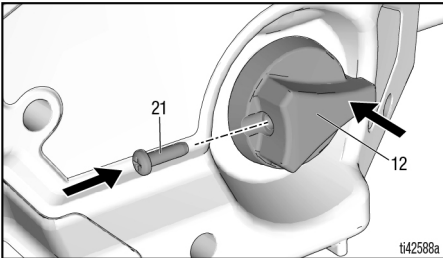

20. After assembly is complete, perform **Assembly Verification**, page 35.

## Assembly Verification

After assembly is complete, perform the following steps to verify proper operation. If sprayer fails one of the steps, repeat sprayer repair procedures.

- Rotate Prime Pump/Spray knob to make sure it rotates forward to the spray position and down to the prime pump position.
- Fill cup assembly (10) with water and verify sprayer primes and sprays. Follow setup instructions in sprayer operation manual for proper priming and spraying procedure.

# Replacement Parts

## Replacement Parts

 Torque to 18 ± 5 in-lbs  
(18 ± 0.6 N·m)

 Torque to 55 - 65 in-lbs  
(6.2 - 7.3 N·m)

 Torque to 15 - 20 in-lbs  
(1.7 - 2.3 N·m)

 Torque to 100 in-lbs  
(11.3 N·m)

 Torque to 9 - 11 in-lbs  
(1.0 - 1.2 N·m)

 Torque to 10 - 15 in-lbs  
(1.1 - 1.7 N·m)

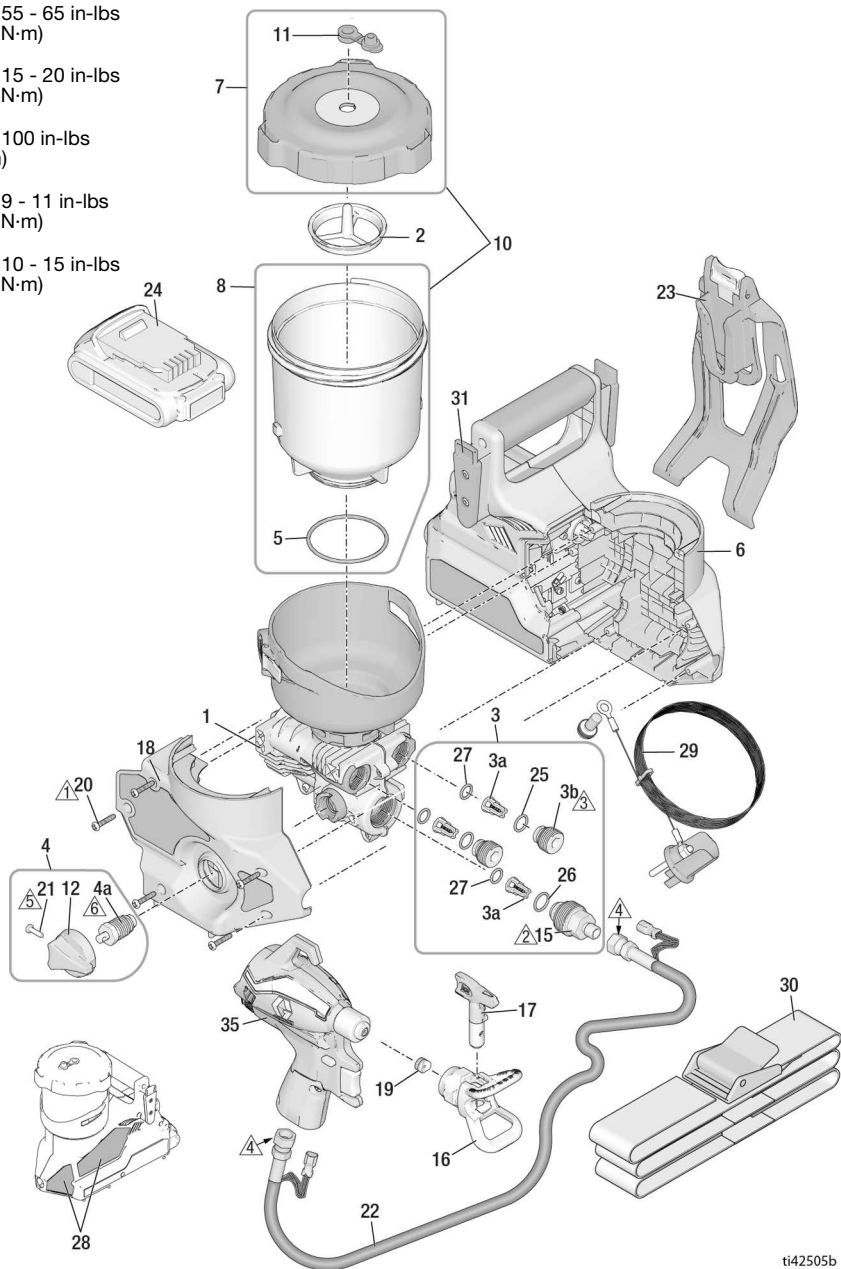

ti42505b

## Parts List

Ref.	Order Part No.	Description
1	18H072	Kit, pump assembly, <i>includes 3, 4</i>
2	18H073	Kit, filter, 60 mesh, 3 pack
	18H074	Kit, filter, 100 mesh, 3 pack
3	18H075	Kit, outlet valve repair, <i>includes 3 of 3a, 2 of 3b, 2 of 25, 1 of 26, 3 of 27, 1 of 15</i>
3a		Outlet valve assembly
3b		Outlet valve plug
4	2000079	Prime/Spray valve and knob, <i>includes 4a, 12, 1 of 21</i>
4a		Prime valve
5	19F703	O-ring
6	18H076	Kit, control, motor, enclosure, <i>includes 18, 28</i>
7	18H077	Kit, lid, plug, label
8	18H078	Kit, cup, 32 oz., <i>includes 5</i>
10	18H079	Kit, cup, lid, plug, o-ring, label, <i>includes 7, 8</i>
11	18H080	Kit, plug, 3 pack
12	17M882	Prime knob
13	19F832	Screw, torx
14	119236	Screw, torx
15	2000209	Kit, hose adapter
16	246215	Guard, spray tip, FFLP
17	FFLP514	Spray tip
	FFLP210	Spray tip
	FFLP410	Spray tip
18	18H083	Kit, enclosure, door, <i>includes 5 of 20</i>
19	17P501	Kit, tip seat and seal, 5 pack
20	18H096	Screw, cross-head
21	128726	Screw, cross-head
22	2000354	Kit, hose
23	18F977	Holster
24*		Li-ion Compact Battery Pack DEWALT
	17P474	20V 2.0 Ah - USA
	17P557	18V 2.0 Ah - Europe/AP
	17P556	18V 2.0 Ah - Japan
	17P558	18V 2.0 Ah - ANZ
	17Y586	18V 2.0 Ah - Korea
*		Li-ion Battery Charger DEWALT (not shown)
	17P475	120V - USA
	17P560	230V - Europe/AP
	17P559	100V - Japan
	17P561	230V - ANZ
	17Y587	230V - Korea
	17M883	Case, storage (not shown)
25	17T582	O-ring
26	2000827	O-ring

# Replacement Parts

Ref.	Order Part No.	Description
27	18D981	O-ring
---	243103	Pump Armor, 1 quart (not shown)
28▲	18H084	Kit, warning labels
		Medical alert card (not shown)
▲	17R476	English, Spanish, Portuguese (Brazil)
	17A134	English, Chinese, Korean
	179960	English, Spanish, French
	17F690	Dutch, German, Italian
29	18H085	Kit, ground
30	18F891	Belt
31	18F810	Adapter, belt slide
35	18H059	Kit, bare gun, no tip or tip guard
37	18H126	Kit, solvent gasket (qty. 5), <i>includes removal/installation tool</i>
---	18H081	Kit, label, brand, Ultra (not shown)
---	18H082	Kit, label, brand, Ultimate (not shown)
* Battery and charger are dependent upon in country requirements.		
▲ Replacement safety labels, tags, and cards are available at no cost.		

**NOTE:** Gun 18H059 and Hose 2000354 are designed for use with the QuickShot sprayer only.

## Replacement Parts

### Extended Repair Parts

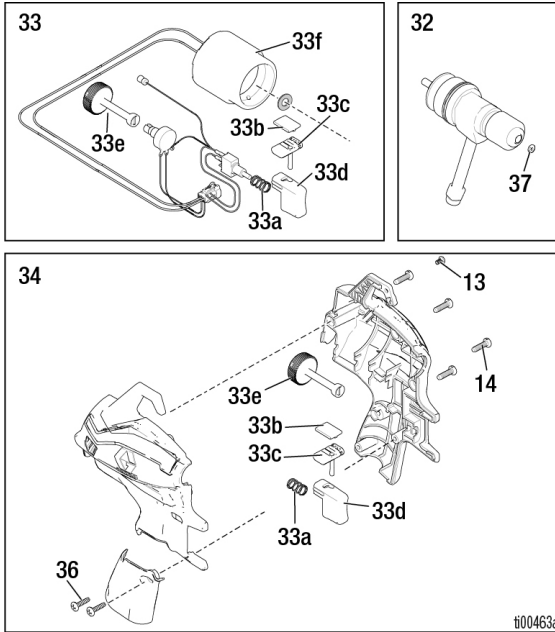

### Parts List

Ref.	Order Part No.	Description
32	18H056	Kit, needle valve, <i>includes 1 of 37</i>
33	18H057	Kit, solenoid, pot, trigger, switch
33a		Spring, gun
33b		Spring, plastic, sliding
33c		Slide, lock, trigger
33d		Cap, trigger
33e		Knob, adjustment
33f		Solenoid
34	18H058	Kit, gun housing, <i>includes 33a, 33b, 33c, 33d, 33e</i>
36	19F831	Screw, cross-head

# Technical Specifications

## Technical Specifications

Quickshot Sprayer		
	U.S.	Metric
Max Working Pressure	2000 psi	14 MPa, 138bar
Weight	6.4 lb	2.9 kg
Dimensions:		
Length	12 in.	30.5 cm
Width	6 in.	15.2 cm
Height	10.5 in.	26.7 cm
Storage Temperature Range ♦❖	32° to 113° F	0° to 45° C
Operating Temperature Range ✓	40° to 90° F	4° to 32° C
Storage Humidity Range	0% to 95% relative humidity, non-condensing	
Sound Pressure Level	84.0 dBA	
Sound Power Level †	100 LwA Uncertainty K = 3 LwA	
Vibration level (measured in accordance with ISO 5349)	Vibration total value $a_h = 11.5 \text{ ft/s}^2$	Vibration total value $a_h = 3.5 \text{ m/s}^2$
Charger Power Source	100 - 120 Vac, 50 Hz, 15A, 1 Ø	
	230 Vac, 50 Hz, 16A, 1 Ø	
Battery Voltage (DC)	20 V MAX* 2.0 Ah Li-ion Compact Battery Pack DEWALT	
Maximum tip orifice	0.016 in.	0.41 mm

♦ Pump damage will occur if fluid freezes in pump.

❖ Damage to plastic parts may result if impact occurs in low temperature conditions.

✓ Changes in paint viscosity at very low or very high temperatures can affect sprayer performance.

† All readings were taken within the spray mode at the assumed operator position. Sound power levels were tested to ISO 3744 at 3.3 feet (1m).



# Graco Standard Warranty

Graco warrants all equipment referenced in this document which is manufactured by Graco and bearing its name to be free from defects in material and workmanship on the date of sale to the original purchaser for use. With the exception of any special, extended, or limited warranty published by Graco, Graco will, for a period of twelve months from the date of sale, repair or replace any part of the equipment determined by Graco to be defective. This warranty applies only when the equipment is installed, operated and maintained in accordance with Graco's written recommendations.

This warranty does not cover, and Graco shall not be liable for general wear and tear, or any malfunction, damage or wear caused by faulty installation, misapplication, abrasion, corrosion, inadequate or improper maintenance, negligence, accident, tampering, or substitution of non-Graco component parts. Nor shall Graco be liable for malfunction, damage or wear caused by the incompatibility of equipment with structures, accessories, equipment or materials not supplied by Graco, or the improper design, manufacture, installation, operation or maintenance of structures, accessories, equipment or materials not supplied by Graco.

This warranty is conditioned upon the prepaid return of the equipment claimed to be defective to an authorized Graco distributor for verification of the claimed defect. If the claimed defect is verified, Graco will repair or replace free of charge any defective parts. The equipment will be returned to the original purchaser transportation prepaid. If inspection of the equipment does not disclose any defect in material or workmanship, repairs will be made at a reasonable charge, which charges may include the costs of parts, labor, and transportation.

**THIS WARRANTY IS EXCLUSIVE, AND IS IN LIEU OF ANY OTHER WARRANTIES, EXPRESS OR IMPLIED, INCLUDING BUT NOT LIMITED TO WARRANTY OF MERCHANTABILITY OR WARRANTY OF FITNESS FOR A PARTICULAR PURPOSE.**

Graco's sole obligation and buyer's sole remedy for any breach of warranty shall be as set forth above. The buyer agrees that no other remedy (including, but not limited to, incidental or consequential damages for lost profits, lost sales, injury to person or property, or any other incidental or consequential loss) shall be available. Any action for breach of warranty must be brought within two (2) years of the date of sale.

**GRACO MAKES NO WARRANTY, AND DISCLAIMS ALL IMPLIED WARRANTIES OF MERCHANTABILITY AND FITNESS FOR A PARTICULAR PURPOSE, IN CONNECTION WITH ACCESSORIES, EQUIPMENT, MATERIALS OR COMPONENTS SOLD BUT NOT MANUFACTURED BY GRACO.** These items sold, but not manufactured by Graco (such as electric motors, switches, hose, etc.), are subject to the warranty, if any, of their manufacturer. Graco will provide purchaser with reasonable assistance in making any claim for breach of these warranties.

In no event will Graco be liable for indirect, incidental, special or consequential damages resulting from Graco supplying equipment hereunder, or the furnishing, performance, or use of any products or other goods sold hereto, whether due to a breach of contract, breach of warranty, the negligence of Graco, or otherwise.

## **FOR GRACO CANADA CUSTOMERS**

The Parties acknowledge that they have required that the present document, as well as all documents, notices and legal proceedings entered into, given or instituted pursuant hereto or relating directly or indirectly hereto, be drawn up in English. Les parties reconnaissent avoir convenu que la rédaction du présent document sera en Anglais, ainsi que tous documents, avis et procédures judiciaires exécutés, donnés ou intentés, à la suite de ou en rapport, directement ou indirectement, avec les procédures concernées.

# Graco Information

For the latest information about Graco products, visit [www.graco.com](http://www.graco.com).

For patent information, see [www.graco.com/patents](http://www.graco.com/patents).

**TO PLACE AN ORDER**, contact your Graco distributor or call 1-888-541-9788 to identify the nearest distributor.

*All written and visual data contained in this document reflects the latest product information available at the time of publication. Graco reserves the right to make changes at any time without notice.*

Original instructions. This manual contains English. MM 3A9301

**Graco Headquarters:** Minneapolis  
**International Offices:** Belgium, China, Japan, Korea

**GRACO INC. AND SUBSIDIARIES • P.O. BOX 1441 • MINNEAPOLIS MN 55440-1441 • USA**

**Copyright 2022, Graco Inc. All Graco manufacturing locations are registered to ISO 9001.**

[www.graco.com](http://www.graco.com)  
Revision F, April 2023